

1 2 3 4 5 6 7 8

A
B
C
D
E
F

A
B
C
D
E
F

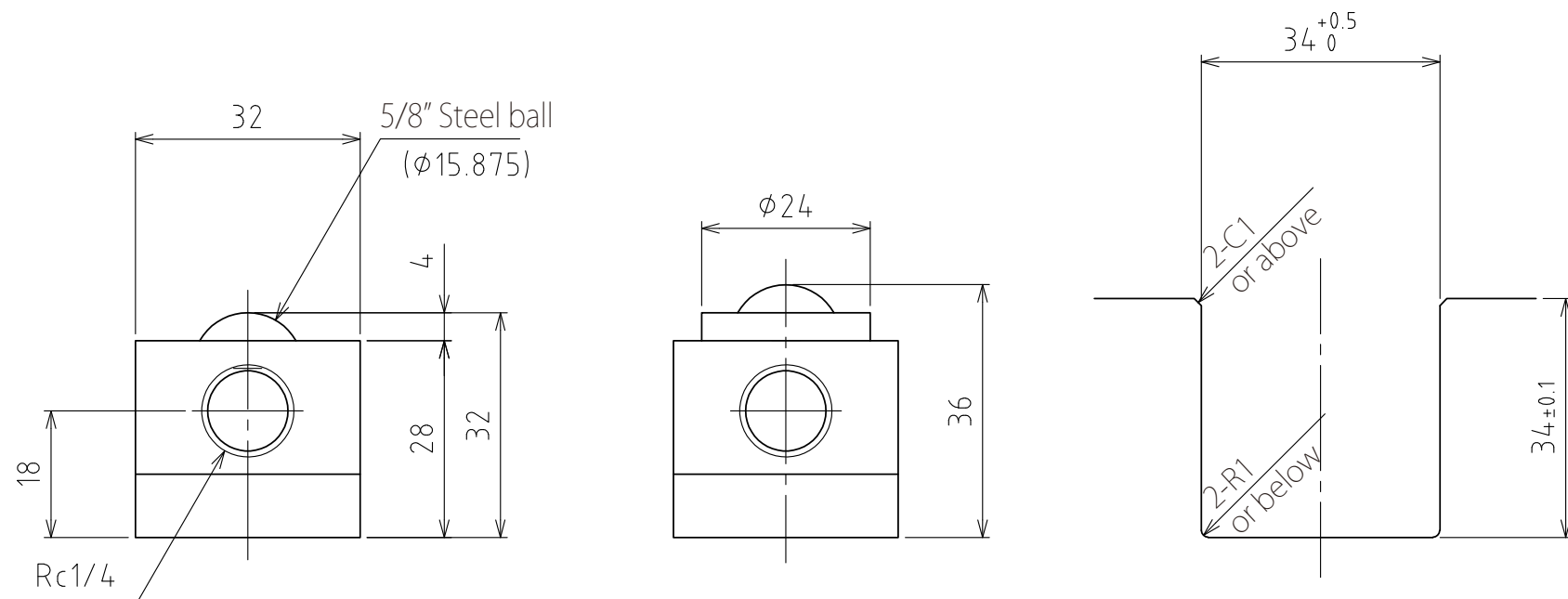
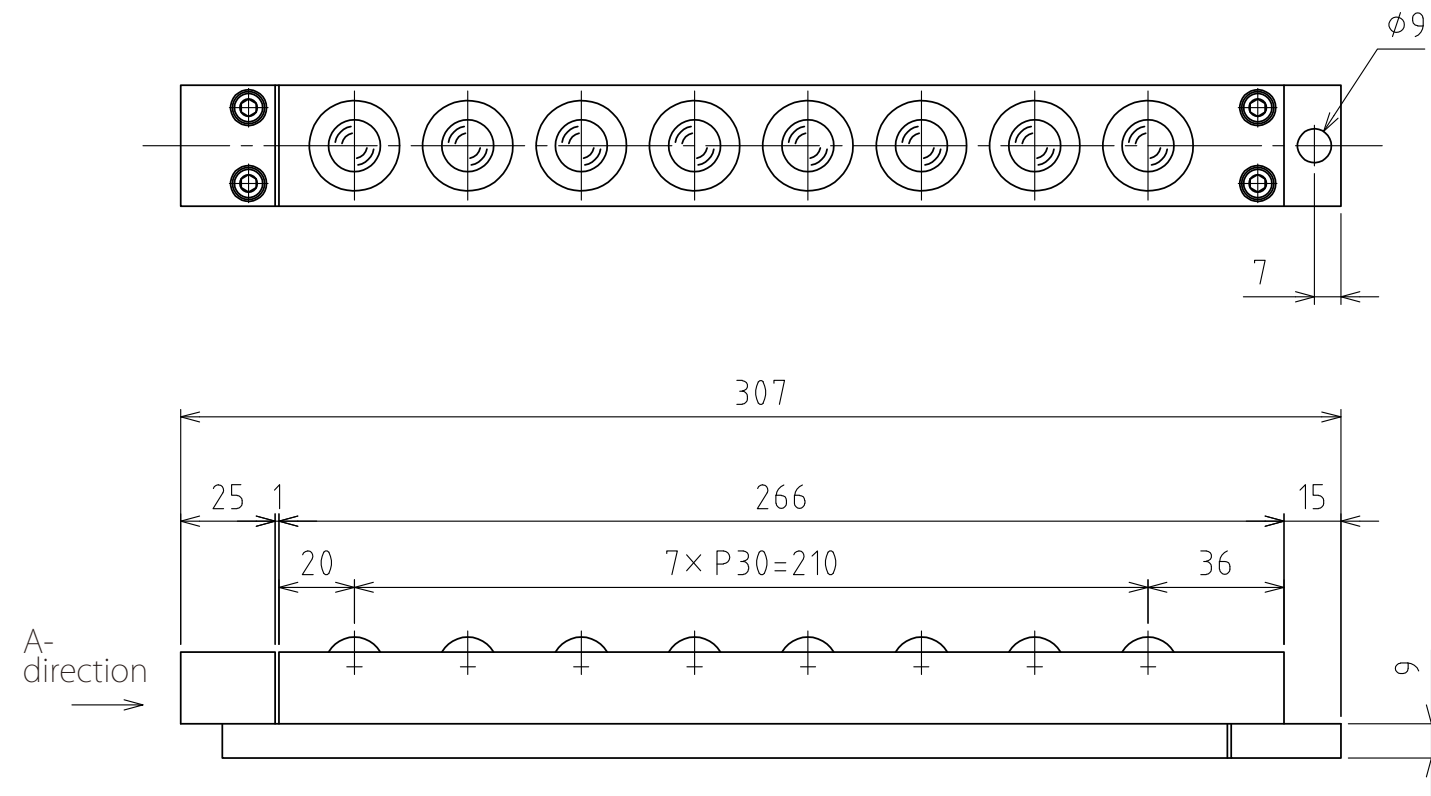

View A

Rising
(stroke 4mm)

Recommended groove dimensions

(Scale 1:1)

spec

Series	AFU-3232series	
Freebear	8pcs	
Material	Ball	SUJ2
	Ball seat	SCM415
	Body	Steel
Weight	1.8kg	

Capacity	Air pressure [MPa(kgf/cm ²)]	Load capacity (Unit) [kN(kgf)]	Load capacity (One freebear) [kN(kgf)]
	0.3 (3.1)	0.96(97.6)	0.12(12.2)
0.4 (4.1)	1.28(130.4)	0.16(16.3)	
0.5 (5.1)	1.60(163.2)	0.20(20.4)	
0.6 (6.1)	1.92(196.0)	0.24(24.5)	

設計 DESIGNED BY	古内	2021/07/27	名称 TITLE
製図 DRAWN BY	古内	2021/07/27	Pneumatically Actuated freebear unit
検図 CHECKED BY	技術部 坂根	承認 APPROVED BY	技術部 花村
尺度 SCALE	1:2	サイズ SIZE	A3
第三角法			AFU-3232-8
			図面番号 DRAWING NO. SD-01251-F01
			変更回数 REV.MARK

1 2 3 4 5 6 7 8