

C-5HS

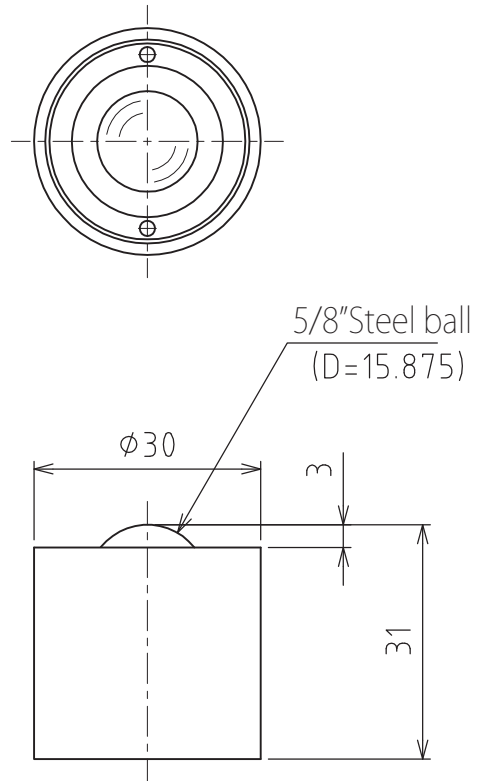

Spring sinking allowance : 2mm
Mounting strength : 196N(20kgf)
Strength required to sink by 2mm : 294N(30kgf)

Allowable load : 196N(20kgf)
Weight : 115g