

C-6DZ

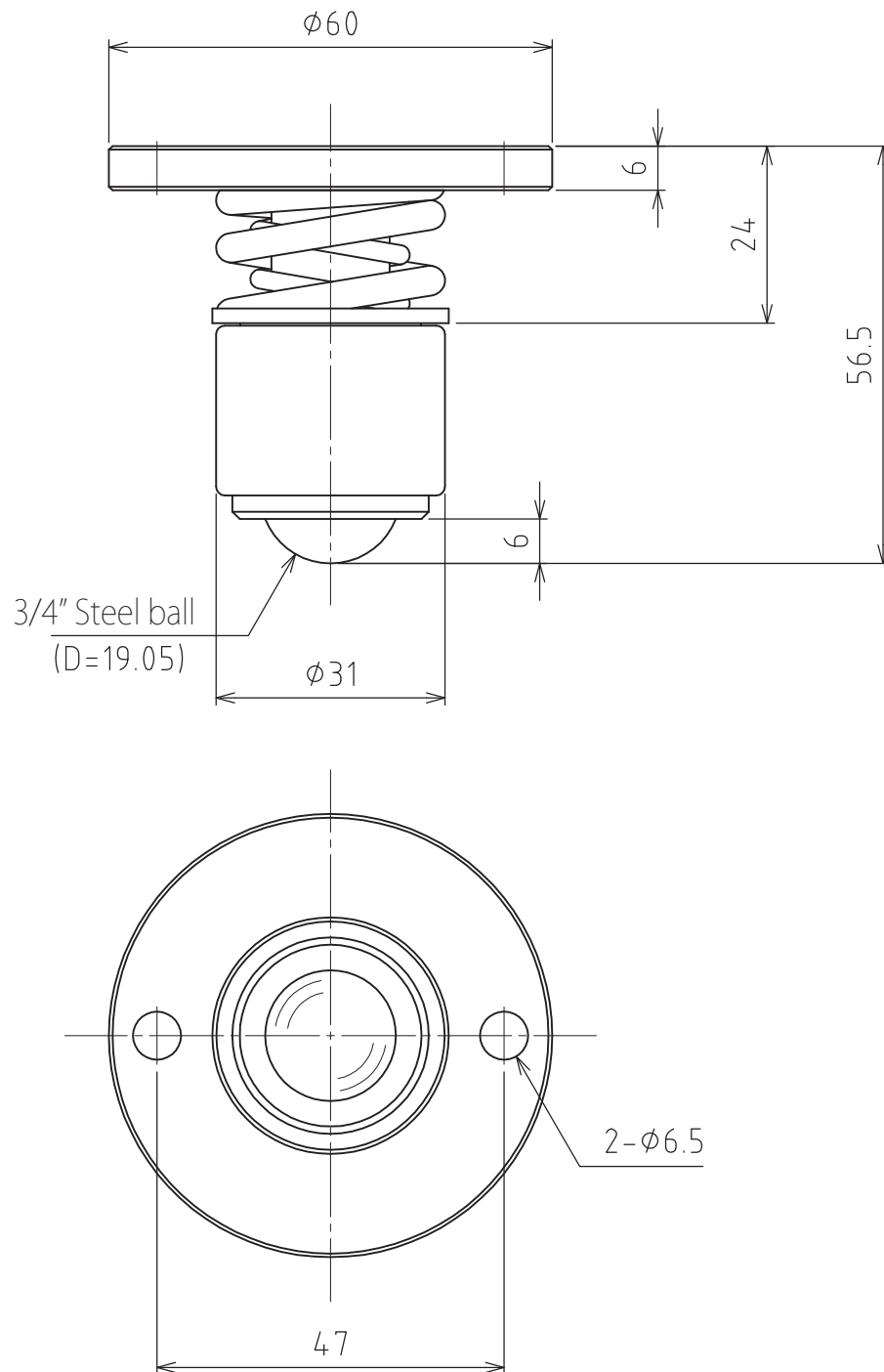

Spring sinking allowance : 2mm
Mounting strength : 490N(50kgf)
Max. strength : 686N(70kgf)

Allowable load : 490N(50kgf)
Weight : 322g