

C-6HS

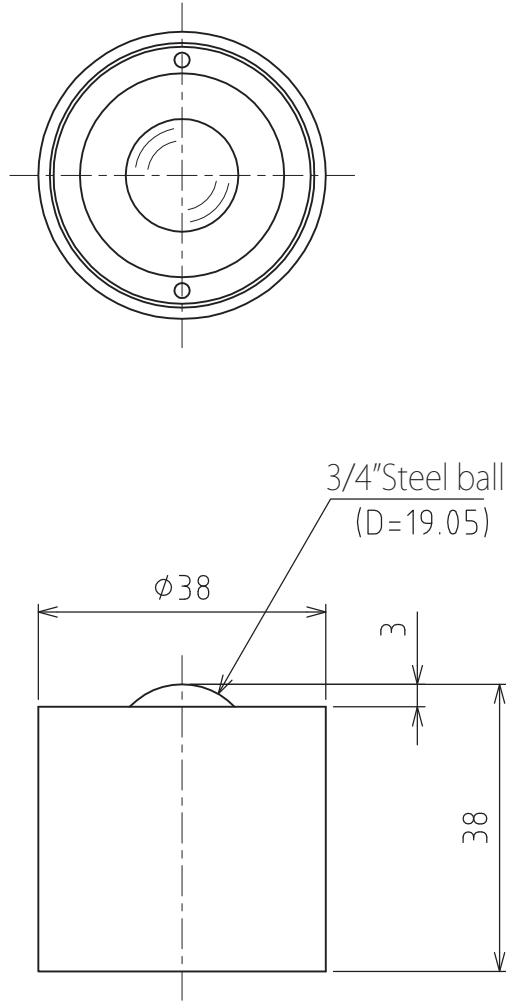

Spring sinking allowance : 2mm
Mounting strength : 490N(50kgf)
Strength required to sink by 2mm : 736N(75kgf)

Allowable load : 490N(50kgf)
Weight : 230g