

# C-8HS-200

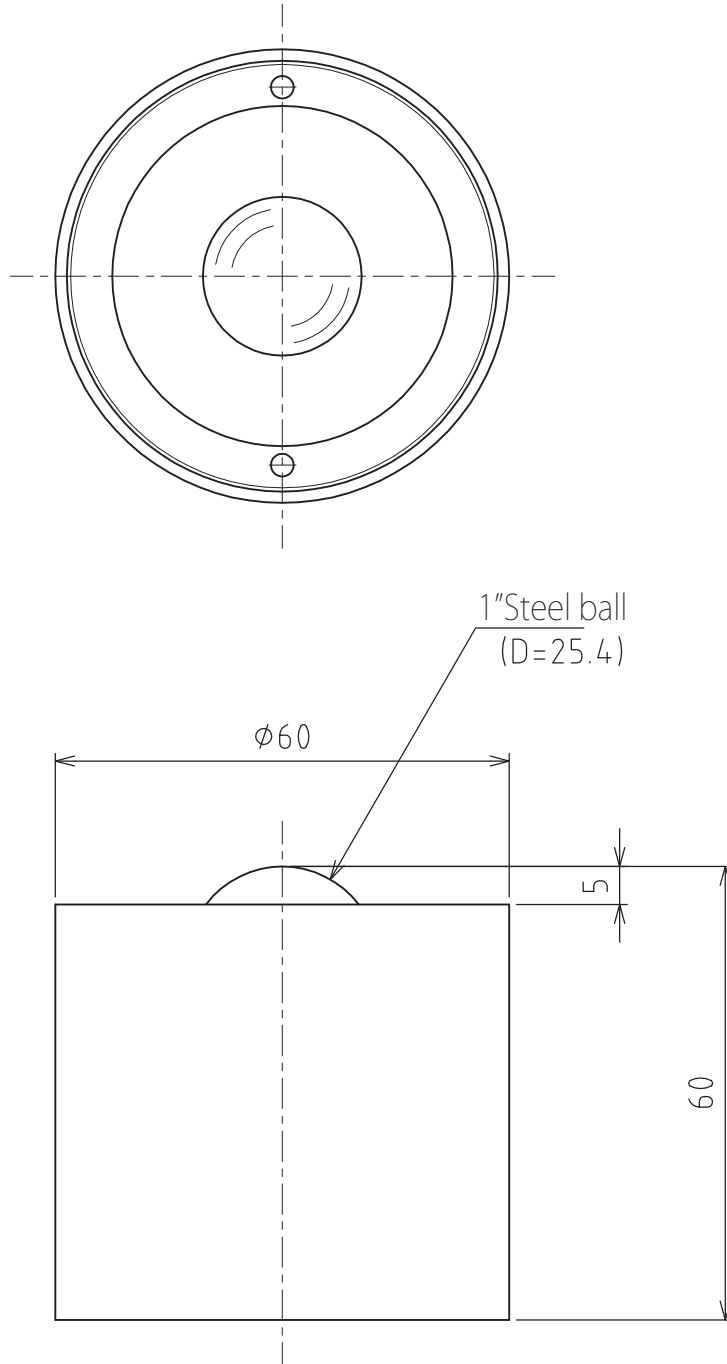

Spring sinking allowance : 2mm  
Mounting strength : 1961N(200kgf)  
Strength required to sink by 2mm : 2941N(300kgf)

Allowable load : 1961N(200kgf)  
Weight : 800g