

1 2 3 4 5 6 7 8

A  
B  
C  
D  
E  
F

A  
B  
C  
D  
E  
F

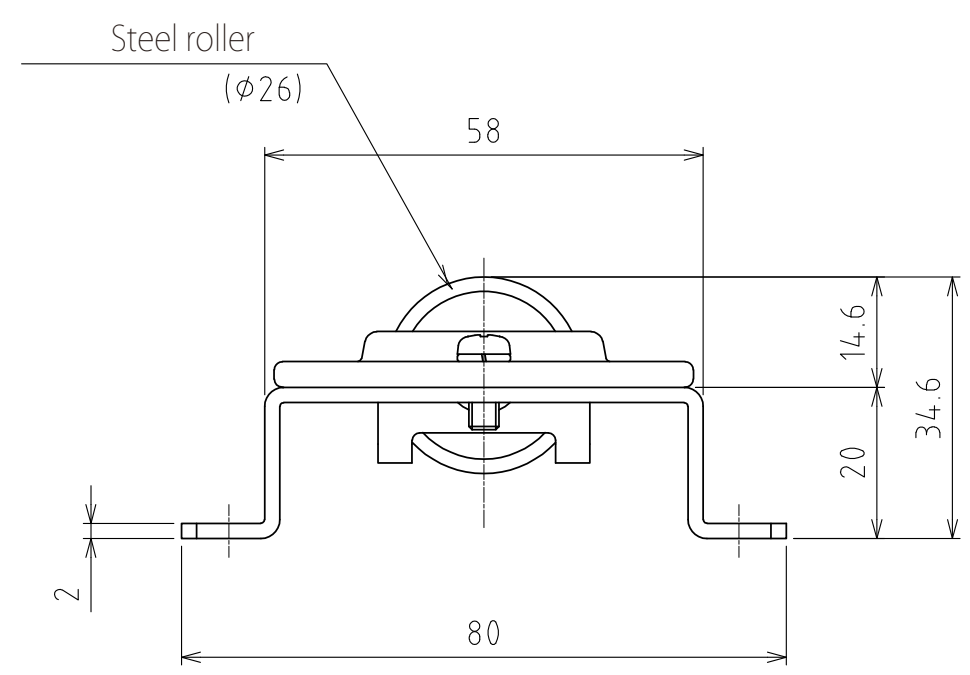
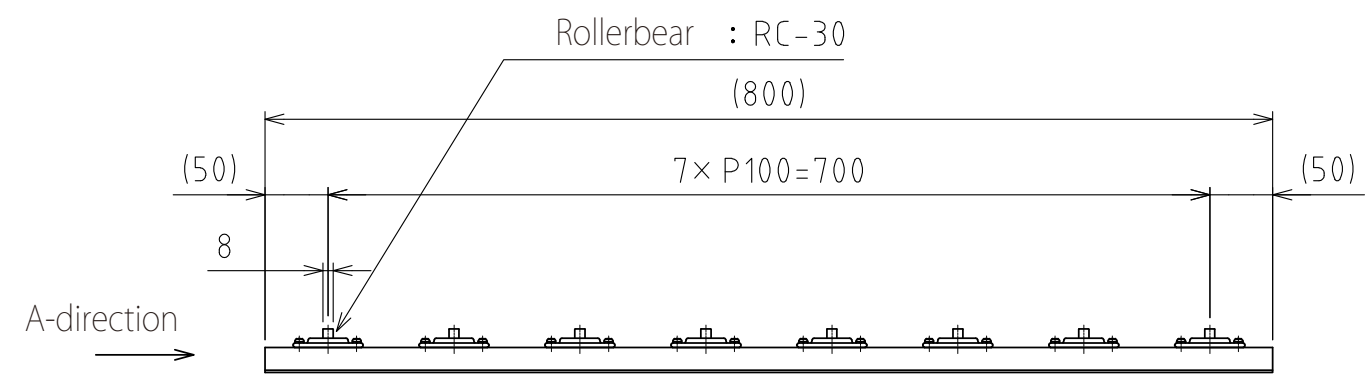
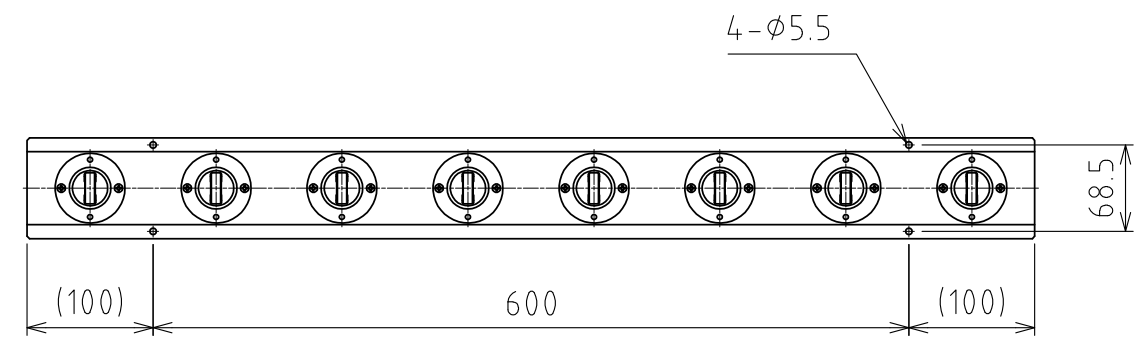

View A  
(Scale 1 : 1)

Freebear : RC-30 (8pcs.) (Parallel)  
Weight : 1.8kg

設計 DESIGNED BY	鈴木	2021/11/11	名称 TITLE
製図 DRAWN BY	鈴木	2021/11/11	
検図 CHECKED BY	技術部 坂根 21.12.27	承認 APPROVED BY	技術部 花村 21.12.28
尺度 SCALE	1:6	サイズ SIZE	A3
第三角法			
			図面番号 DRAWING NO. SB-00387-F01
			変更回数 REV.MARK 変更回数

1 2 3 4 5 6 7 8