

1 2 3 4 5 6 7 8

A
B
C
D
E
F

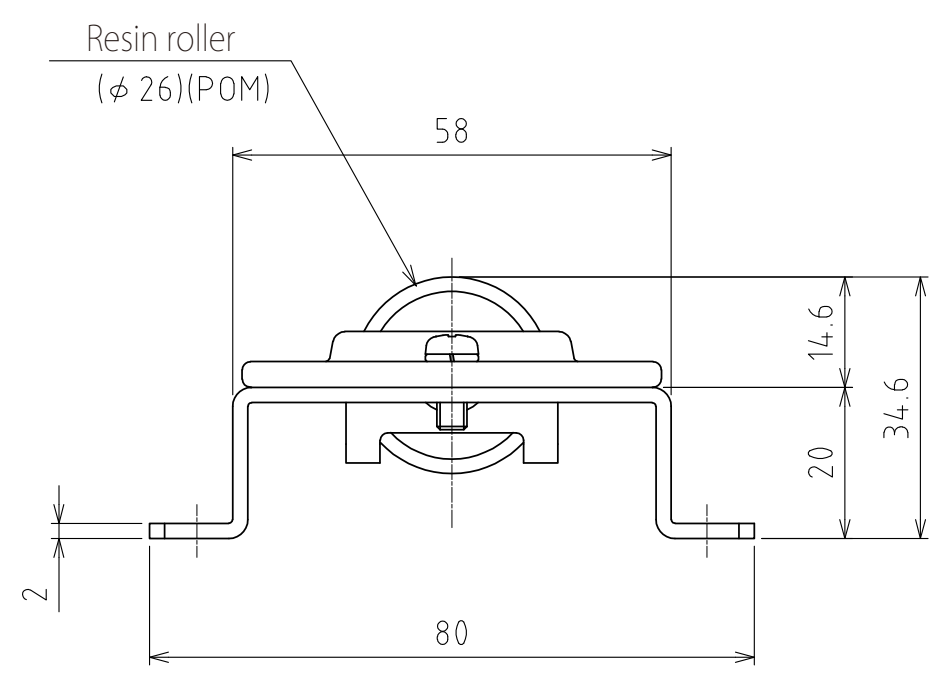
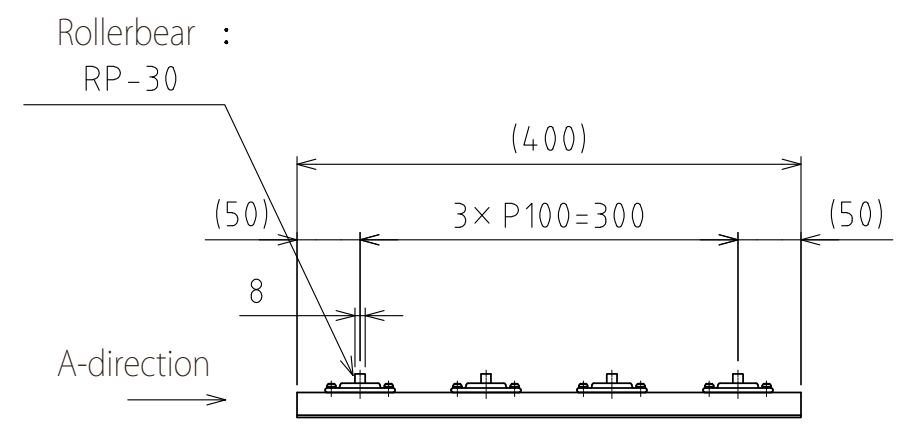
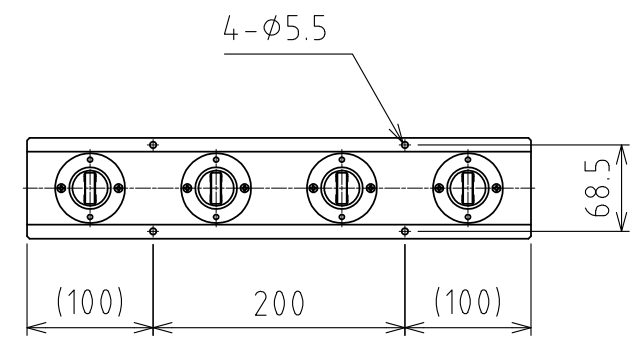

View A
(Scale 1 : 1)

Freebear : RP-30 (4pcs.) (Parallel)
Weight : 0.8kg

設計 DESIGNED BY	鈴木	2021/12/23	名称 TITLE
製図 DRAWN BY	鈴木	2021/12/23	
検図 CHECKED BY	坂根	21.12.27	承認 APPROVED BY
			花村
尺度 SCALE	1:6	サイズ SIZE	A3
第三角法			
			図面番号 DRAWING NO.
			SB-00401-F01
			変更回数 REV.MARK

1 2 3 4 5 6 7 8